

COMPARISON BETWEEN SPEED CONTROL OF DC MOTOR USING ADJUSTABLE FUZZY LOGIC CONTROLLER AND PID CONTROLLER

Raman Chetal¹, Divya Gupta²

¹*Department of Electrical Engineering, Baba Banda Singh Bahadur Engineering College, Fatehgarh Sahib, Punjab (India), ramanc2008@gmail.com*

²*Department of Electrical Engineering, Baba Banda Singh Bahadur Engineering College, Fatehgarh Sahib, Punjab (India), divya.gupta@bbsbec.ac.in*

Abstract - DC motor is used in many manipulator applications. But for proper working of DC motor and for its better response we required a controller in these applications. In this paper designing of an adjustable fuzzy logic controller is done in which we adjust the values of control parameters of PID controller on the basis of error and change in error as inputs of fuzzy controller. These controlled parameters provides exact mathematical modelling to PID controller . The whole work is carried out in MATLAB/Simulink environment. Finally comparison is done between the result of adjustable fuzzy controller and PID controller.

Keywords – Fuzzy Logic Controller, MATLAB/Simulink, DC motor speed control, PID controller.

I. INTRODUCTION

The development of high performance motor drives is very important in industrial as well as other purpose applications. Generally, a high performance motor drive system must have good dynamic speed command tracking and load regulating response. The dc motors are used in various applications such as defense, industries, Robotics etc. DC drives, because of their simplicity, ease of application, reliability and favorable cost have long been a backbone of industrial applications. DC drives are less complex with a single power conversion from AC to DC. DC drives are normally less expensive for most horsepower ratings. DC motors have a long tradition of use as adjustable speed machines and a wide range of options have evolved for this purpose. In these applications, the motor should be precisely controlled to give the desired performance. Many varieties of control schemes such as P, proportional integral (PI), PID, adaptive, and FLCs, have been developed for speed control of dc motors.

Problem of non linearity arises when we apply conventional algorithm like (P,PI,PD,PID) on speed control of DC motor. These non linearities degrades the performance of DC motor. Actual nonlinear model of DC motor is difficult to find and we always use approximated model for it. Fuzzy control is the one of the best control which overcomes these type of difficulties.

II. DC MOTOR

The DC or direct current motor works on the principal, when a current carrying conductor is placed in a magnetic field, it experiences a torque and has a tendency to move. This is known as motoring action. If the direction of electric current in the wire is reversed, the direction of rotation also reverses. When magnetic field and electric field interact they produce a mechanical force, and based on that the working principle of dc motor established. The direction of rotation of this motor is given by Fleming's left hand rule. DC motors are most suitable for wide range speed control and are there for many adjustable speed drives.

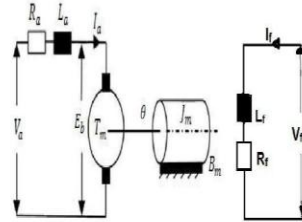

Fig 1: DC motor

III. PID CONTROLLER

The ideal version of the PID controller is given by the formula

$$u(t) = k_p e(t) + \int_0^t e(T) dT + k_d \frac{de}{dt}$$

where \$u\$ is the control signal and \$e\$ is the control error (\$e = r - y\$). The reference value, \$r\$, is also called the setpoint. The control signal is thus a sum of three terms: a proportional term that is proportional to the error, an integral term that is proportional to the integral of the error, and a derivative term that is proportional to the derivative of the error. The controller parameters are proportional gain \$k_p\$, integral gain \$k_i\$ and derivative gain \$k_d\$. The controller can also be parameterized as

$$u(t) = k_p \left(e(t) + \frac{1}{T_i} \int_0^t e(T) dT + T_d \frac{de(t)}{dt} \right)$$

where \$T_i\$ is the integral time constant and \$T_d\$ the derivative time constant. The proportional part acts on the present value of the error, the integral represents an average of past errors and the derivative can be interpreted as a prediction of future errors based on linear extrapolation, as illustrated in Figure 2.

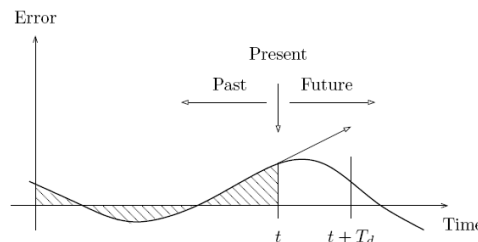

Fig 2: PID control action

A PID controller take control action on past,present and prediction of future control errors.

IV. FUZZY LOGIC CONTROLLER

The Fuzzy logic controller uses the fuzzy logics to make the decisions and to control the output of the controller. The main components in fuzzy logic controller

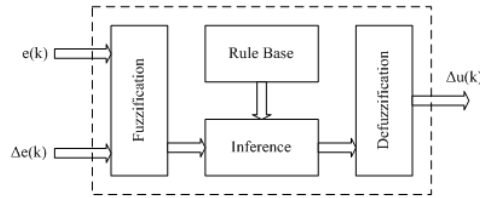

Fig. 3: Fuzzy Logic basic block diagram

are fuzzification, rule-base, inference and defuzzification as shown in figure 3. There are two inputs to the controller – error $e(k)$ and change in error $\Delta e(k)$. The Fuzzification block converts the crisp inputs to fuzzy inputs. The rules are formed in rule base and are applied in inference block. The defuzzification converts the fuzzy output to the crisp output. The fuzzy inference is carried out by using Mamdani’s method, and the defuzzification uses the centre of gravity method.

V. METHODOLOGY

The fuzzy logic controller used in the system has two inputs. The error is the difference between actual speed and desired (reference) speed of motor. The equations for error and change in error is given by

$$E(k) = A(k) - E(k) \tag{1}$$

$$CE(K) = E(k) - E(K-1) \tag{2}$$

The outputs of the controller are K_p, K_i, K_d which further feed to PID controller. In the rule base, there are 5 membership functions of error and change in error each, whereas, the output is based on 7 membership functions. There are 25 rules in the rule base for K_p, K_i, K_d . The rules are formed as shown in below tables.

Table 1: Rule Base for K_p

E	NM	LN	Z	LP	PM
CE					
NM	PB	PB	PB	PB	PB
LN	P	P	P	PM	PB
Z	NB	NB	NM	N	N
LP	P	P	P	PM	PB
PM	PB	PB	PB	PB	PB

Table 2: Rule Base for K_i

E	NM	LN	Z	LP	PM
CE					
NM	Z	Z	Z	Z	Z
LN	N	N	N	N	N
Z	NM	NM	NB	NM	NM
LP	N	N	N	N	N
PM	Z	Z	Z	Z	Z

Table 3: Rule Base for K_d

E	NM	LN	Z	LP	PM
CE					
NM	NB	N	Z	PM	PB
LN	N	P	PM	PB	PB
Z	Z	PM	PM	PB	PB
LP	P	PB	PB	PB	PB
PM	PB	PB	PB	PB	PB

The Input Output membership functions are shown in figures 4,5,6,7 and 8 respectively.

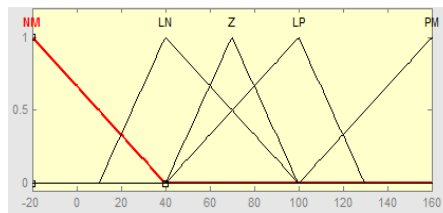

Fig. 4: Membership functions for input variable $E(k)$

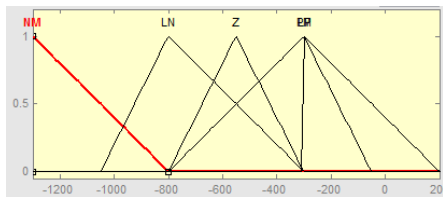

Fig. 5: Membership functions for input variable $CE(k)$

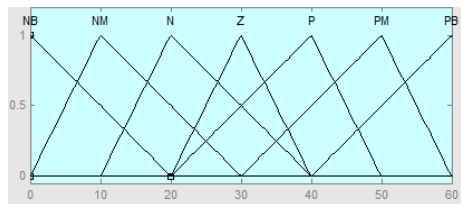

Fig. 6: Membership functions for output variable K_p

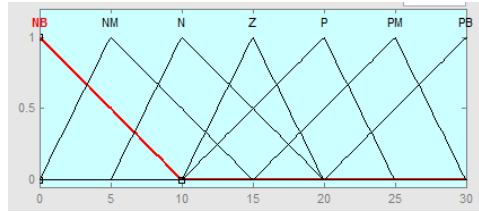

Fig. 7: Membership functions for output variable K_i

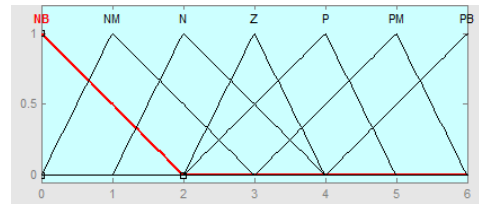

Fig. 8: Membership functions for output variable K_d

The developed MATLAB/Simulink model is shown in figure 9.

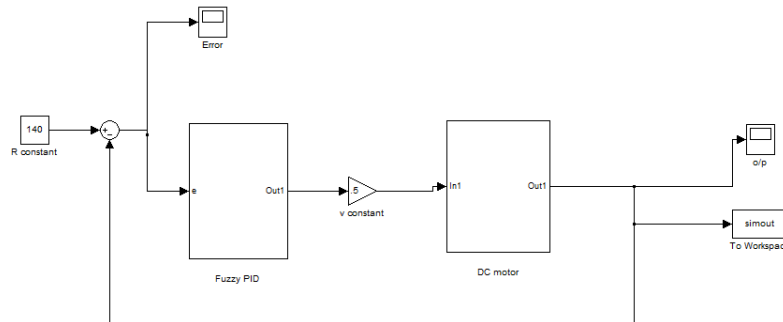

Fig. 9: Simulink Model for Adjustable Fuzzy Logic Controller

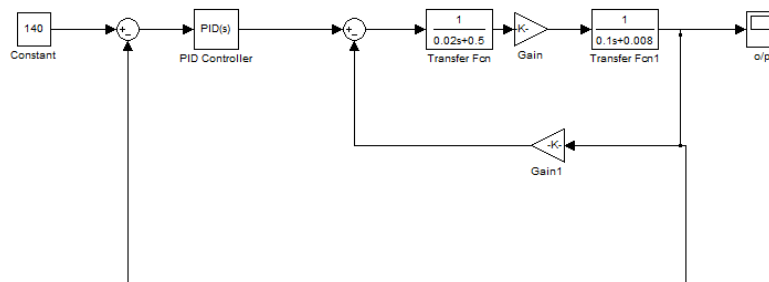

Fig. 10: Simulink Model for PID controller

VI. RESULTS AND CONCLUSION

The proposed model was simulated in MATLAB/Simulink environment. The adjustment of three parameters K_p, K_i, K_d of PID is required for its better performance. This adjustment of parameters was done with the help of fuzzy logic controller which shows better response than that of only PID controller. There are some results obtained which shows that in adjustable fuzzy logic controller smaller overshoot, less settling time, less rising time and less steady state error are present which are very high in PID controller.

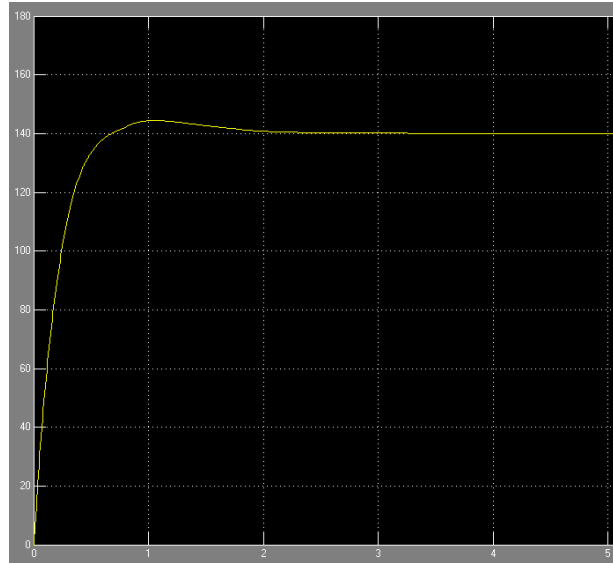

Fig. 11: Speed Vs time response of controlled DC motor using adjustable fuzzy logic controller

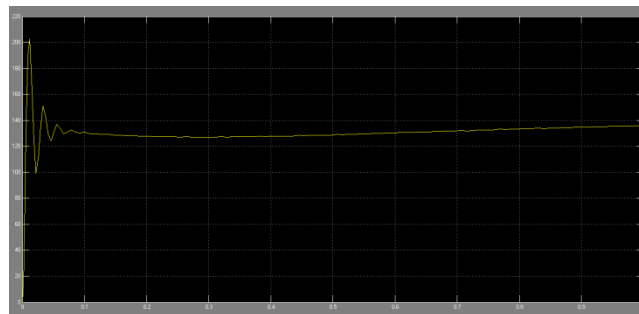

Fig. 12: Speed Vs time response of controlled DC motor using PID controller

The results conclude that by using adjustable fuzzy logic controller, system (motor) response can be more efficient than conventional controller (like PID).

REFERENCES

- [1] K.H. Ang, G. Chong and Y. Li, "PID control system analysis, design and technology," IEEE transaction on Control System Technology, Vol.13, No.4, 2005, pp. 559-576

- [2] C.T. Johnson and R.D. Lorenz, "Experimental identification of friction and its compensation in precise, position controlled mechanism." IEEE Trans. Ind ,Applicat, vol.28, no.6, 1992.
- [3] ManafeddinNamazov and OnurBasturk, "DC motor position control using fuzzy proportional-derivative controllers with different defuzzification methods," Turkish Journal of Fuzzy Systems (eISSN: 1309–1190), Vol.1, No.1, pp. 36-54, 2010
- [4] Dayang Faridah Binti Shebli, "Control of dc motor using PI controller", Kolej university teknikal kebangsaan Malayisa.
- [5] Y. Tipsuwan, Y. Chow, "Fuzzy Logic Micmcontroller Implementation for DC Motor Speed Control". IEEE. 1999.
- [6] Bomediene Alloua, Abdellah Laouf Brahim Gasbaoui and ABdessalamAbderrahamani,"Neuro -Fuzzy DC Motor speed Control Using Particle Swarm Optimization," Leonaro Electronic Journal of Practices andTechnologies ISSN,1583-1078.