

Multilevel SPWM Inverter with Variable Carrier Synchronization

Mr. Zala Jaydipsinh B.¹, Prof. V. J. RUPAPARA²

¹PG Student, Power Electronics, L.E.College, Morbi, Gujarat-India Gujarat Technological University

E-mail ID: zalajaydeepsinh000@gmail.com

²Assist. Prof., L.E.College, Morbi, Gujarat-India Gujarat Technological University, Email Id:
vjrupapara@yahoo.com

Abstract—Multilevel inverter generates stepped AC signal. Based on sequence of switching and duration of each step we can minimize the output Voltage THD. Sinusoidal Pulse Width Modulation (SPWM) is a very popular control method and widely used in power electronics inverter circuits to reduce lower level Harmonics. We connect several SPWM inverters in cascade and receive multilevel SPWM output. There are different SPWM methods to receive multilevel SPWM output voltage. And there are: (a) In Phase Disposition PWM (PH Disposition) (b) Phase Opposition Disposition PWM (PO Disposition) (c) Alternative opposition Disposition PWM (APO Disposition) (d) 90° Phase Shifted Disposition PWM (90° PS Disposition). From all these methods there are creates an many triangular carrier waveforms which are phase shifted or level shifted from main triangular carrier signal and they all compared with reference Sine Wave signal to generates switching pulse which gives Sinusoidal output voltage with different harmonics level.

Keywords-SPWM-Sinusoidal Pulse Width Modulation, Multilevel Inverter, THD%, Filter

I. INTRODUCTION

In recent time, there are many source of DC power Supply like battery, Solar Cells, Rectifiers etc. and we need to convert it in to AC by Using of Power Inverter. There are many type of inverters which converts DC input power into AC output voltage by different Switching patterns. But they have an also creates Harmonics in output voltage and we need to use filter it. So we use SPWM Sinusoidal Pulse Width Modulation Inverter which gives AC output with Harmonics at switching frequency of higher frequency then it. So it is easily filtered by using small low pass filter which is compact with respect to other inverter filters.

II. MULTILEVEL SPWM INVERTER

Multilevel inverter generates an staircase multiple steps output which reduces the output THD. As we increase the number of step levels in multilevel inverter we receives more sinusoidal output and harmonic distortion reduced as per level of inverter increases.

We also reduce higher level harmonics and increase output voltage RMS by using multilevel SPWM inverter which is normal cascade SPWM inverters.

III. VARIOUS TYPES OF SPWM TECHNIQUES

A. In Phase Disposition PWM (PH)

In this Method, all carriers signals have same frequency, amplitude and phase with each other. But they all have are in different levels. And that all are compared with same reference Sinusoidal signals to generate gating signals of different switches of inverters.

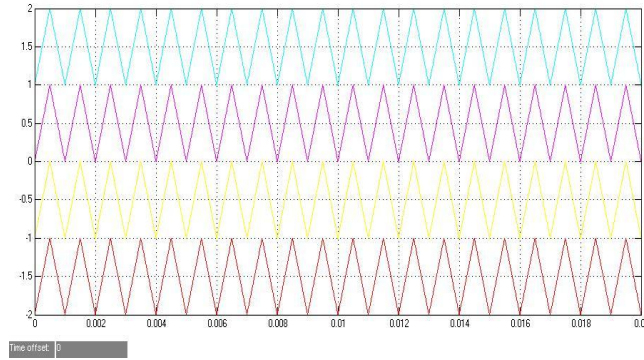

Fig.1. Phase Disposition PWM (PH)

B. Phase Opposition Disposition PWM (PO)

In this Method, all carriers signals have same frequency, amplitude but different in phase. Carrier signals above the reference zero voltage are in 180° out of phase with the carrier signals below the reference zero voltage. And that all are compared with same reference Sinusoidal signals to generate gating signals of different switches of inverters.

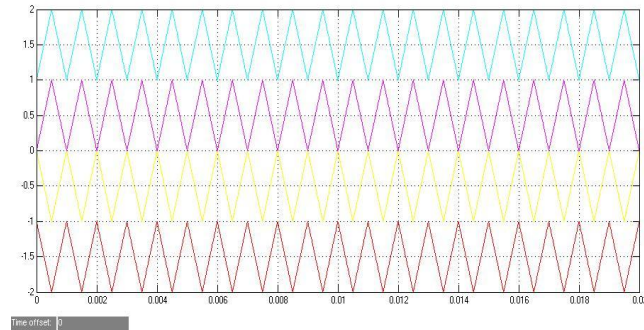

Fig.2. Phase Opposition Disposition PWM (PO)

C. Alternative opposition Disposition PWM (APO)

In this Method, all carriers signals have same frequency, amplitude but all are out of phase with 180° with each other with different voltage levels. And that all are compared with same reference Sinusoidal signals to generate gating signals of different switches of inverters.

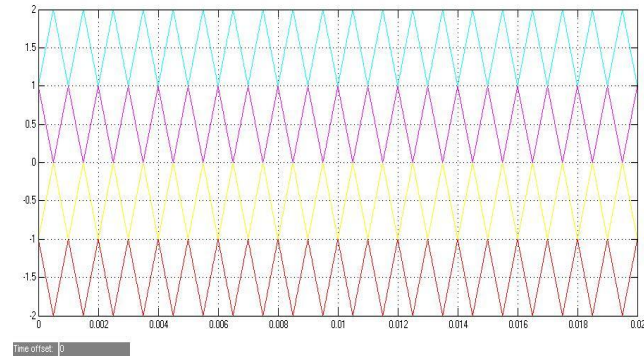

Fig.3. Alternative opposition Disposition PWM (APO)

D. 90° Phase Shifted Disposition PWM (90° PS)

In this Method, all carriers signals have same frequency, amplitude but all are out of phase with 180° with each other with different voltage levels. And that all are compared with same reference Sinusoidal signals to generate gating signals of different switches of inverters.

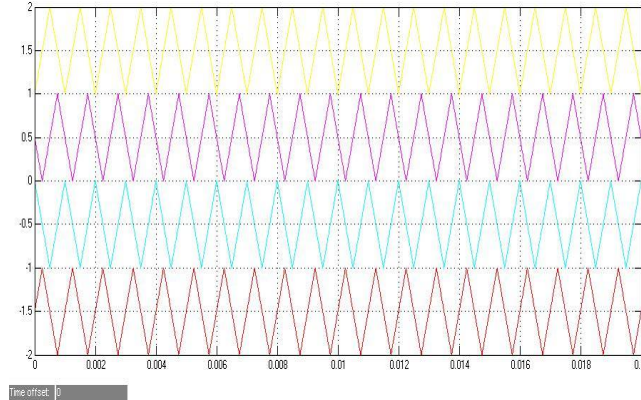

Fig.4. 90° Phase Shifted Disposition PWM (90° PS)

IV. SIMULATION RESULTS

Different Modulation scheme for multilevel inverter are explained under this paper are simulated in MATLAB 2010a. And the Simulink model and associated waveforms and THD simulation are here.

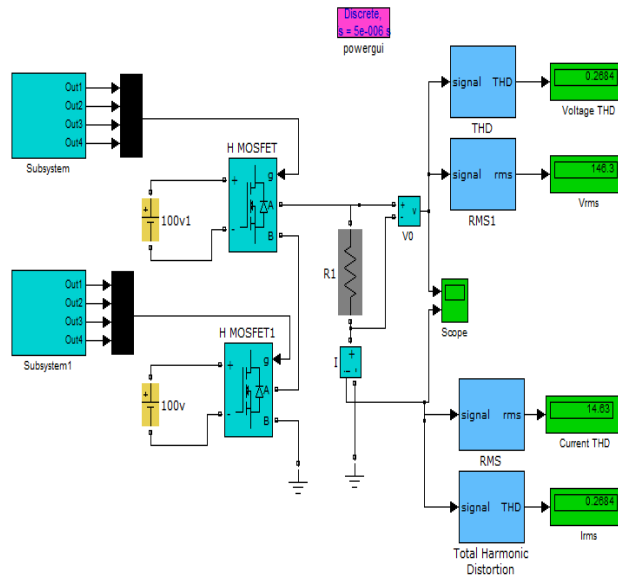
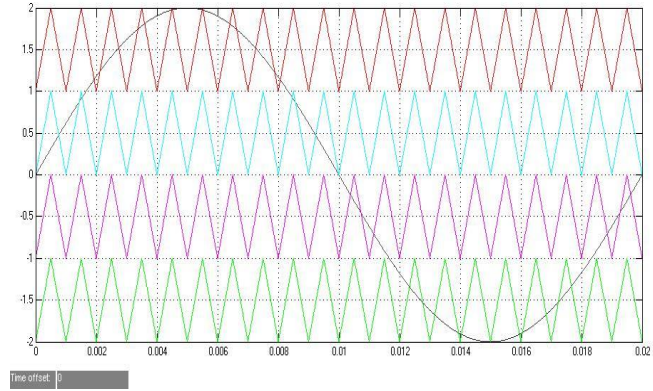
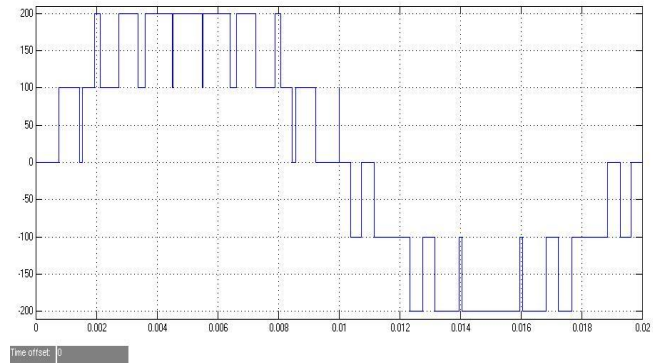

Fig.5. Simulink MATLAB model of 5 level SPWM (2 cascade SPWM) inverter



6(a)



6(b)

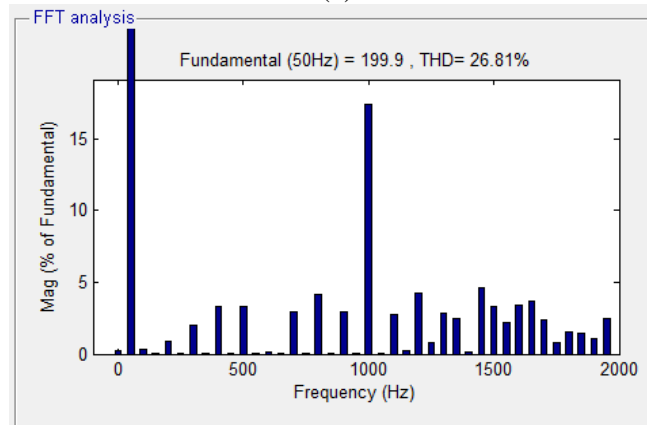

6(c)

Fig.6. In Phase Disposition PWM (PH) (a) Carrier Waveforms
(b) Output Voltage (c) THD%

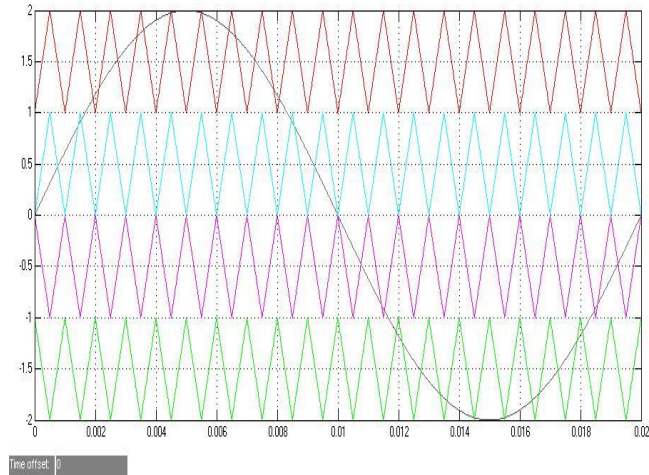

7(a)

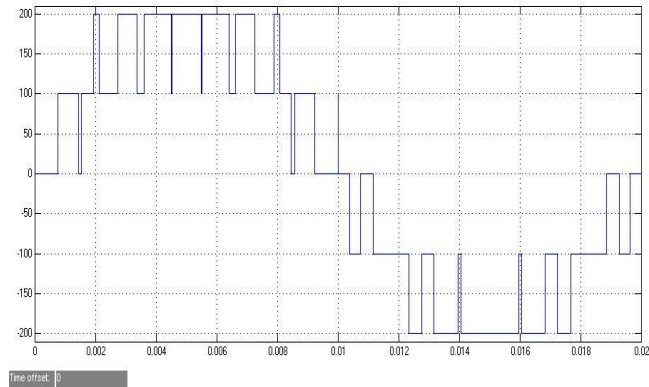

7(b)

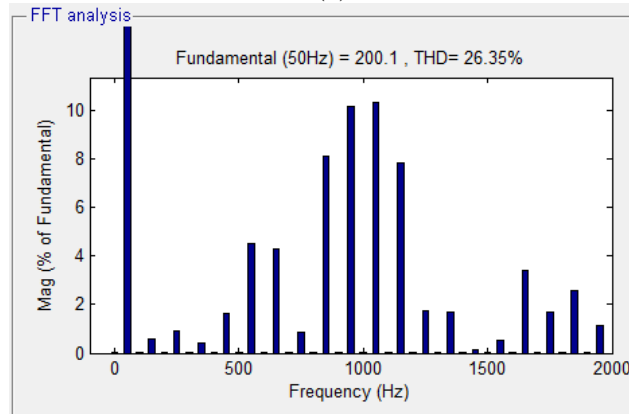

7(c)

Fig.7. Phase Opposition Disposition PWM (PO)
(a) Carrier Waveforms
(b) Output Voltage (c) THD%

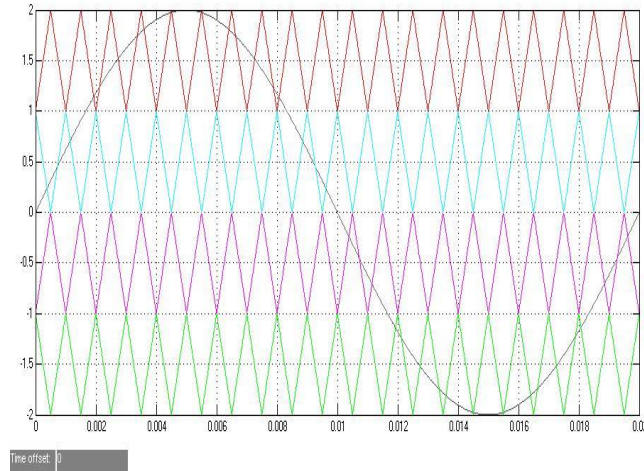

8(a)

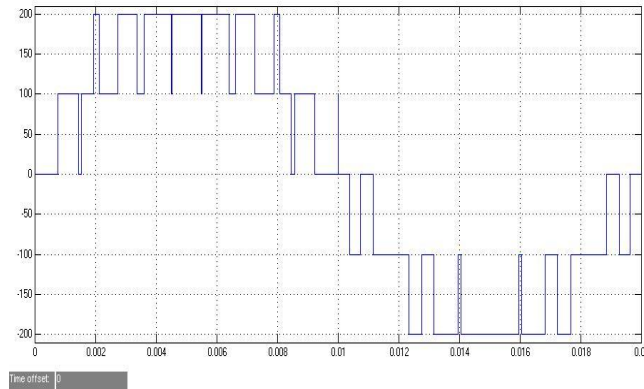

8(b)

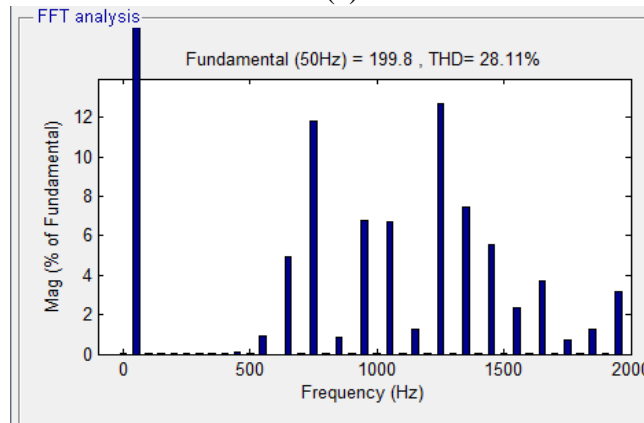

8(c)

Fig.8. Alternative opposition Disposition PWM (APO)
(a) Carrier Waveforms
(b) Output Voltage (c) THD%

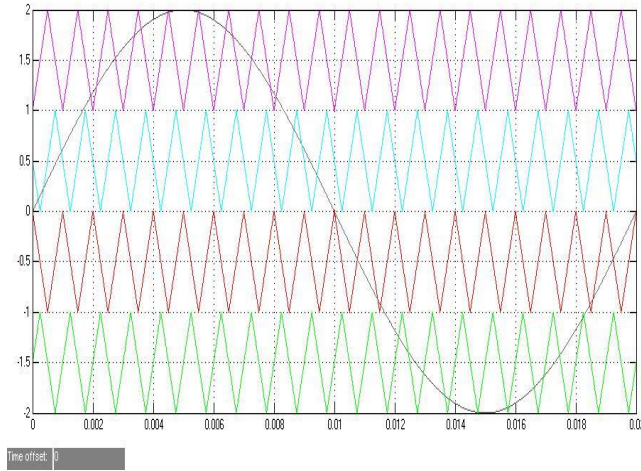

9(a)

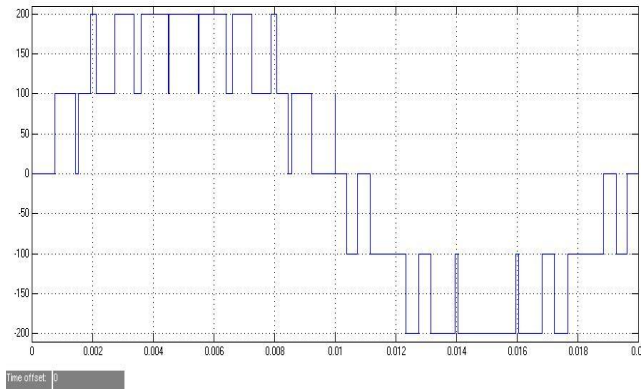

9(b)

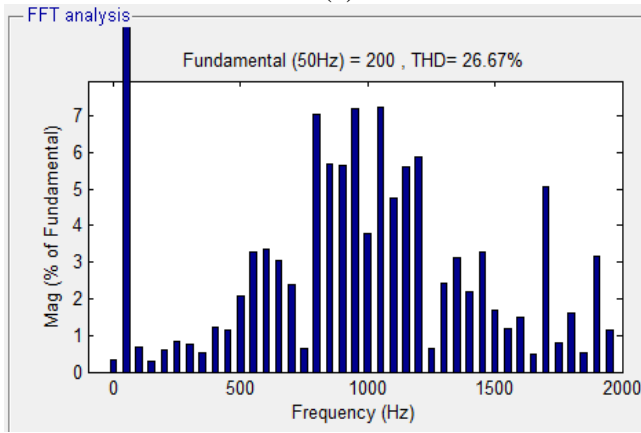

9(c)

Fig.9. 90° Phase Shifted Disposition PWM (90° PS)
 (a) Carrier Waveforms
 (b) Output Voltage (c) THD%

	Method	THD %
1	PH	26.81

2	PO	26.35
3	APO	28.11
4	90° PS	26.67

Table.1- Comparison of different SPWM methods for Multilevel Inverter

V. CONCLUSION

Several Multilevel SPWM methods are discussed here. And these methods have gained more interest in industrial application. In these methods only one reference sinusoidal waveform and one carrier signal needs. From that carrier signal other phase shifted signals may be generated in DSP or microcontroller based scheme. This is also easy to implement in hardware. Based on application we use any of schemes to receive output voltage with lower THD distortion.

REFERENCES

- [1] Vadhiraaj S.K. Narayana Swamy, B.P. Divakar, "Generic SPWM Technique for Multilevel Inverter," IEEE-2013, 978-1-4799-2522-3/13
- [2] M.S.Aspalli, Anil Wamanrao, "Sinusoidal Pulse Width Modulation (SPWM) With Variable Carrier Synchronization for Multilevel Inverter Controllers," IEEE Xplore
- [3] Vassilios G. Agelidis, Anastasios Balouktsis, Calum Cossar, "**Five-Level Selective Harmonic Elimination PWM Strategies and Multicarrier Phase-Shifted Sinusoidal PWM: A Comparison**", IEEE-2005, 0-7803-9033-4/05
- [4] Jayant J. Mane, Shubhada P. Muley, Mohan V. Aware, "Performance of 5-level NPC inverter with Multi-Multicarrier Multi-Modulation technique", *2012 IEEE International Conference on Power Electronics, Drives and Energy Systems December 16-19, 2012, Bengaluru, India*